



1.0 Hz to 100 kHz  
Fixed Frequency

16 Pin DIP  
2-Pole Filters

## Description

The D72 and DP72 Series of low-power, fixed-frequency, linear active filters are high performance, 2-pole filters in a compact package. These Butterworth and Bessel low-pass and Butterworth high-pass filters (D72 only) combine linear active filter design with the space savings of a 16-pin dual in-line package (DIP). Each model comes factory tuned to a user-specified corner frequency between 1 Hz and 100 kHz (DP72, 1 Hz to 5kHz). These fully self-contained units require no external components or adjustments and operate with dynamic input voltage range from non-critical  $\pm 5V$  to  $\pm 18V$  power supplies.

## Features/Benefits:

- Low cost solution for low frequency signal conditioning
- Compact DIP design minimizes board space requirements
- Plug-in ready-to-use, reducing engineering design and manufacturing time
- Factory tuned, no external clocks or adjustments needed saving time and labor of other discrete assembly solutions
- Low harmonic distortion and wide signal-to-noise ratio to 12 bit resolution

## Applications

- Anti-alias filtering
- Vibration & shock analysis
- Automatic test equipment
- Aerospace, navigation and sonar
- Communication systems
- Medical electronics
- Sound and vibration testing
- Noise elimination
- Process control



## Available Low-Pass Models:

<b>D72L2B</b>	2-pole Butterworth	.....	.2
<b>DP72L2B</b>	2-pole Butterworth (Low Power)	.....	.2
<b>D72L2L</b>	2-pole Bessel	.....	.2
<b>DP72L2L</b>	2-pole Bessel (Low Power)	.....	.2

## Available High-Pass Models:

<b>D72H2B</b>	2-pole Butterworth	.....	.2
---------------	--------------------	-------	----

## General Specifications:

Pin-out/package data & ordering information	... .3
---	--------



## Fixed Frequency

## 2-Pole Low-Pass and High-Pass Filters

Model	D72L2B & DP72L2B	D72L2L & DP72L2L	Model	D72H2B
<b>Product Specifications</b>	<b>Low-Pass</b>	<b>Low-Pass</b>		<b>High-Pass</b>
<b>Transfer Function</b>	2-Pole, Butterworth	2-Pole, Bessel	<b>Transfer Function</b>	2-Pole, Butterworth
<b>Size</b>	0.88" x 0.46" x 0.375"	0.88" x 0.46" x 0.375"	<b>Size</b>	0.88" x 0.46" x 0.375"
<b>Range <math>f_c</math></b> D72 DP72	1 Hz to 100 kHz 1 Hz to 5 kHz	1 Hz to 100 kHz 1 Hz to 5 kHz	<b>Range <math>f_c</math></b>	1 Hz to 100 kHz
<b>Theoretical Transfer Characteristics</b>	Appendix A Page 6	Appendix A Page 1	<b>Theoretical Transfer Characteristics</b>	Appendix A Page 26
<b>Passband Ripple</b> (theoretical)	0.0 dB	0.0 dB	<b>Passband Ripple</b> (theoretical)	0.0 dB
<b>DC Voltage Gain</b> (non-inverting)	0 ± 0.1 dB typ.	0 ± 0.1 dB typ.	<b>Voltage Gain</b> (non-inverting)	0 ± 0.1 dB to 100 kHz
<b>Stopband Attenuation Rate</b>	12 dB/octave	12 dB/octave	<b>Stopband Attenuation Rate</b>	12 dB/octave
<b>Power Bandwidth</b>			<b>Power Bandwidth</b>	120 kHz
<b>Small Signal Bandwidth</b>			<b>Small Signal Bandwidth</b>	(-6 dB) 1 MHz
<b>Cutoff Frequency Stability</b> <b>Amplitude</b> <b>Phase</b>	$f_c$ ± 2% max. ± 0.03% /°C -3 dB -90°	$f_c$ ± 2% max. ± 0.03% /°C -3 dB -74.3°	<b>Cutoff Frequency Stability</b> <b>Amplitude</b> <b>Phase</b>	$f_c$ ± 2% max. ± 0.03% /°C -3 dB -90°
<b>Filter Attenuation</b> (theoretical)	1.49 dB      0.80 $f_c$ 3.01 dB      1.00 $f_c$ 30.0 dB      5.62 $f_c$ 40.0 dB      10.0 $f_c$	1.91 dB      0.80 $f_c$ 3.01 dB      1.00 $f_c$ 30.0 dB      7.10 $f_c$ 40.0 dB      12.75 $f_c$	<b>Filter Attenuation</b> (theoretical)	40 dB      0.10 $f_c$ 30 dB      0.18 $f_c$ 3.01 dB      1.00 $f_c$ 0.02 dB      4.00 $f_c$
<b>Total Harmonic Distortion @ 1 kHz</b> D72 DP72	<-70 dB <-70 dB	<-70 dB <-70 dB	<b>Total Harmonic Distortion @ 1 kHz</b> D72	<-70 dB
<b>Wide Band Noise</b> (5 Hz - 2 MHz)	200 $\mu$ Vrms typ.	200 $\mu$ Vrms typ.	<b>Wide Band Noise</b> (5 Hz - 2 MHz)	400 $\mu$ Vrms typ.
<b>Narrow Band Noise</b> (20 Hz - 100 kHz)	50 $\mu$ Vrms typ.	50 $\mu$ Vrms typ.	<b>Narrow Band Noise</b> (20 Hz - 100 kHz)	100 $\mu$ Vrms typ.
<b>Filter Mounting Assembly</b>	FMA-01A	FMA-01A	<b>Filter Mounting Assembly</b>	FMA-01A



## Specification

(25°C and  $V_s \pm 15$  Vdc)

## Pin-Out and Package Data Ordering Information

### Analog Input Characteristics<sup>1</sup>

Impedance	10 k $\Omega$ min.
Voltage Range	$\pm 10$ Vpeak
Max. Safe Voltage	$\pm V_s$

### Analog Output Characteristics

Impedance	1 $\Omega$
Linear Operating Range	$\pm 10$ V
Maximum Current <sup>2</sup>	
D72	$\pm 10$ mA
DP72	$\pm 5$ mA
Offset Voltage	10 mV max. 3 mV typ.
Offset Temp. Coeff.	20 $\mu$ V / °C

### Power Supply ( $\pm V$ )

Rated Voltage	$\pm 15$ Vdc
Operating Range	$\pm 5$ to $\pm 18$ Vdc
Maximum Safe Voltage	$\pm 18$ Vdc
Quiescent Current <b>D72</b>	

5 mA max.  
3 mA typ.

### Quiescent Current **DP72**

1.5 mA max.  
600  $\mu$ A typ.

### Temperature

Operating	0 to + 70 °C
Storage	- 25 to + 85 °C

### Notes:

1. Input and output signal voltage referenced to supply common.
2. Output is short circuit protected to common.  
DO NOT CONNECT TO  $\pm V_s$ .

All dimensions are in inches  
All case dimensions  $\pm 0.01$ "  
Grid Dimensions 0.1" x 0.1"

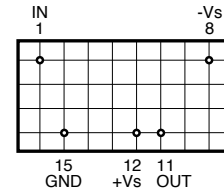

BOTTOM VIEW

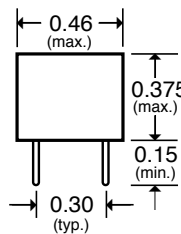

FRONT VIEW

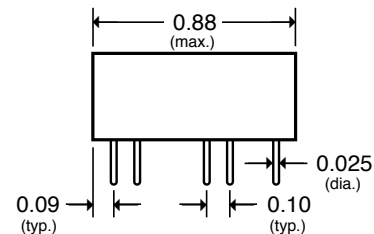

SIDE VIEW

**Filter Mounting Assembly-See FMA-01A**

## Ordering Information

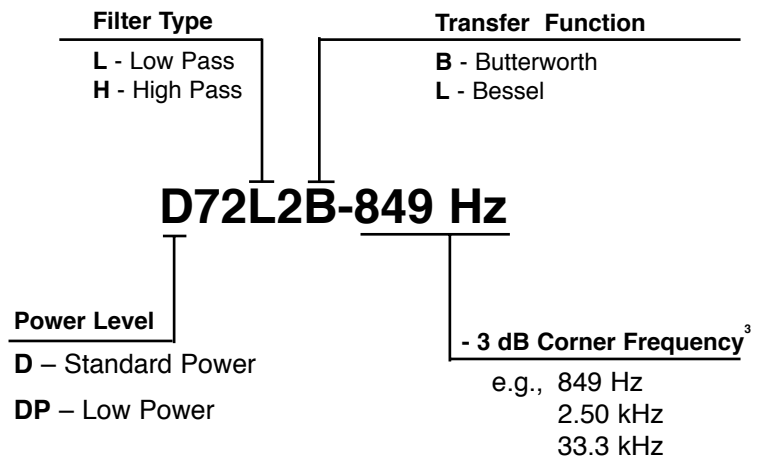

3. How to Specify Corner Frequency:  
Corner frequencies are specified by attaching a three digit frequency designator to the basic model number. Corner frequencies can range from 1 Hz to 100 kHz.



**Appendix A**

**Theoretical Transfer Characteristics**

f/fc (Hz)	Amp (dB)	Phase (deg)	Delay <sup>1</sup> (sec)
0.00	0.00	0.00	.217
0.10	-0.027	-7.79	.216
0.20	-0.108	-15.6	.216
0.30	-0.248	-23.4	.216
0.40	-0.448	-31.1	.215
0.50	-0.712	-38.8	.212
0.60	-1.044	-46.4	.208
0.70	-1.443	-53.8	.202
0.80	-1.907	-60.9	.195
0.85	-2.161	-64.4	.190
0.90	-2.430	-67.7	.185
0.95	-2.71	-71.0	.180
1.00	-3.01	-74.2	.175
1.10	-3.63	-80.3	.164
1.20	-4.28	-86.0	.153
1.30	-4.95	-91.3	.141
1.40	-5.65	-96.2	.130
1.50	-6.35	-101	.120
1.60	-7.05	-105	.110
1.70	-7.75	-109	.101
1.80	-8.44	-112	.093
1.90	-9.13	-115	.085
2.00	-9.80	-118	.079
2.25	-11.4	-125	.064
2.50	-12.9	-130	.053
2.75	-14.4	-134	.045
3.00	-15.7	-138	.038
3.25	-17.0	-141	.033
3.50	-18.2	-144	.028
4.00	-20.3	-148	.022
5.00	-24.0	-155	.014
6.00	-27.1	-159	.010
7.00	-29.7	-162	.007
8.00	-32.0	-164	.005
9.00	-34.1	-166	.004
10.0	-35.9	-167	.004

**Frequency Response**

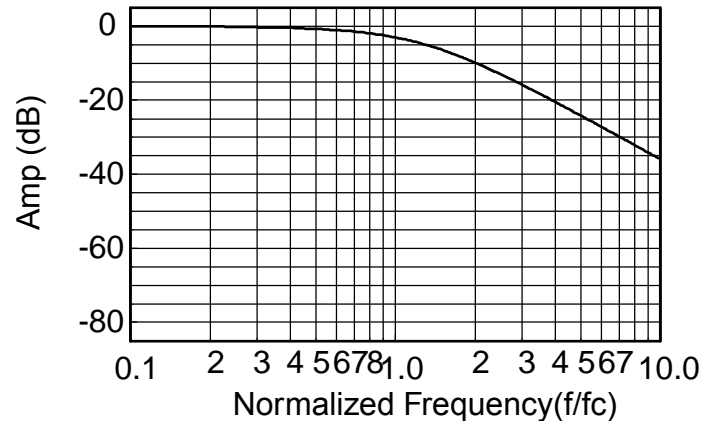

**Delay (Normalized)**

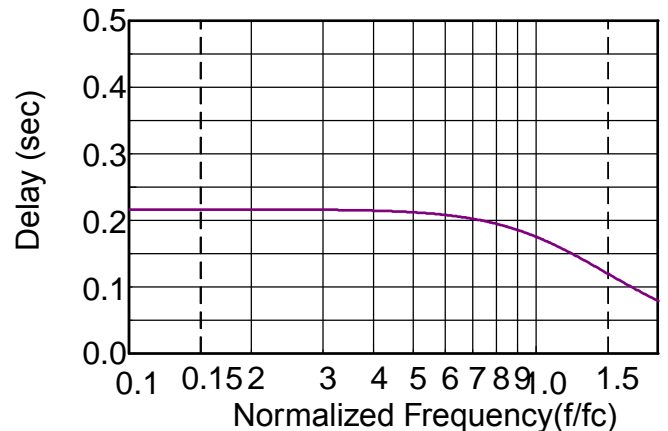

**Step Response**

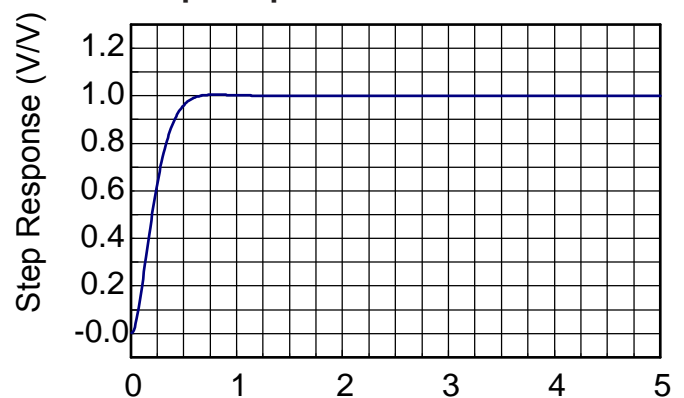

**1. Normalized Group Delay:**

The above delay data is normalized to a corner frequency of 1.0Hz. The actual delay is the normalized delay divided by the actual corner frequency (fc).

$$\text{Actual Delay} = \frac{\text{Normalized Delay}}{\text{Actual Corner Frequency (fc) in Hz}}$$



**Appendix A**

**Theoretical Transfer Characteristics**

f/fc (Hz)	Amp (dB)	Phase (deg)	Delay <sup>1</sup> (sec)
0.00	0.00	0.00	.225
0.10	0.00	-8.13	.227
0.20	-0.01	-16.4	.234
0.30	-0.035	-25.0	.243
0.40	-0.110	-34.0	.255
0.50	-0.263	-43.3	.265
0.60	-0.529	-53.0	.271
0.70	-0.935	-62.7	.270
0.80	-1.491	-72.3	.262
0.85	-1.824	-77.0	.255
0.90	-2.191	-81.5	.246
0.95	-2.59	-85.8	.236
1.00	-3.01	-90.0	.225
1.10	-3.92	-97.7	.202
1.20	-4.88	-105	.179
1.30	-5.86	-111	.157
1.40	-6.85	-116	.138
1.50	-7.83	-121	.121
1.60	-8.78	-125	.106
1.70	-9.71	-128	.094
1.80	-10.6	-131	.083
1.90	-11.5	-134	.074
2.00	-12.3	-137	.066
2.25	-14.3	-142	.051
2.50	-16.0	-146	.041
2.75	-17.6	-149	.033
3.00	-19.1	-152	.027
3.25	-20.5	-154	.023
3.50	-21.8	-156	.020
4.00	-24.1	-159	.015
5.00	-28.0	-164	.009
6.00	-31.1	-166	.006
7.00	-33.8	-168	.005
8.00	-36.1	-170	.004
9.00	-38.2	-171	.003
10.0	-40.0	-172	.002

**Frequency Response**

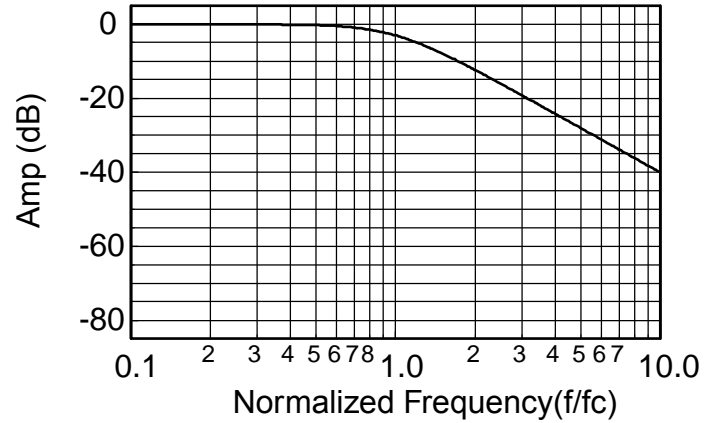

**Delay (Normalized)**

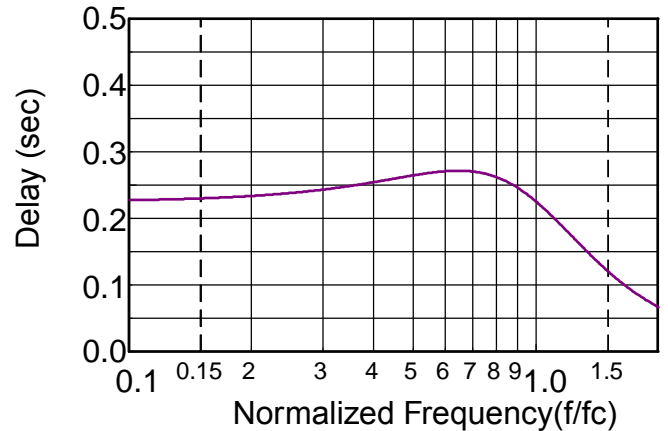

**Step Response**

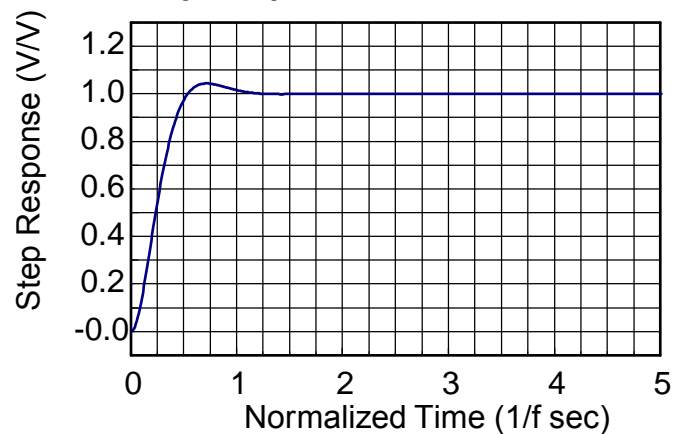

**1. Normalized Group Delay:**

The above delay data is normalized to a corner frequency of 1.0Hz. The actual delay is the normalized delay divided by the actual corner frequency (fc).

$$\text{Actual Delay} = \frac{\text{Normalized Delay}}{\text{Actual Corner Frequency (fc) in Hz}}$$



**Theoretical Transfer Characteristics**

f/fc (Hz)	Amp (dB)	Phase (deg)	Delay <sup>1</sup> (sec)
0.10	-40.00	172	.227
0.20	-27.97	164	.234
0.30	-20.95	155	.243
0.40	-16.03	146	.255
0.50	-12.31	137	.265
0.60	-9.40	127	.271
0.70	-7.13	117	.270
0.80	-5.37	108	.262
0.85	-4.65	103	.255
0.90	-4.02	98.5	.246
0.95	-3.48	94.2	.236
1.00	-3.01	90.0	.225
1.20	-1.71	75.5	.179
1.40	-1.01	64.1	.138
1.60	-0.62	55.4	.106
1.80	-0.40	48.7	.083
2.00	-0.26	43.3	.066
2.50	-0.11	34.0	.041
3.00	-0.05	27.9	.027
4.00	-0.02	20.7	.015
5.00	-0.01	16.4	.009
6.00	-0.00	13.6	.006
7.00	-0.00	11.7	.005
8.00	-0.00	10.2	.004
9.00	-0.00	9.04	.003
10.0	-0.00	8.13	.002

**Frequency Response**

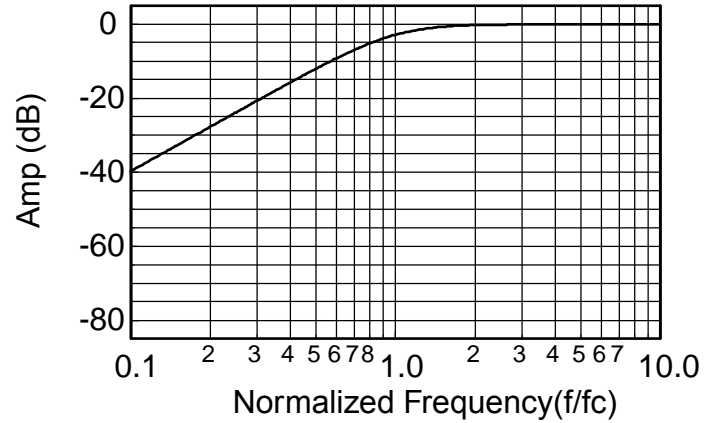

**1. Normalized Group Delay:**

The above delay data is normalized to a corner frequency of 1.0Hz. The actual delay is the normalized delay divided by the actual corner frequency (fc).

$$\text{Actual Delay} = \frac{\text{Normalized Delay}}{\text{Actual Corner Frequency (fc) in Hz}}$$